



ALE-1500(3D)

Auto Patternless Lens Edger



New Technologies And Powerful Functions
Simple operation interface provides
with accurate operation experience.

- Built in 3D Forced Sharp Edge program
- Easy get Mini Sharp Edge
- Unique 3D forced sharp edge function, with the ratio of the sharp edge adjustable as desired



Forced Sharp Edge Effect:
Say Goodbye to the Hassle of
Adjusting Machine Level.
Multiple Sharp Edge Positions
Available to Meet Your Differ-
ent Lens Material
Requirements.



Adapt lenses with more materials and degrees

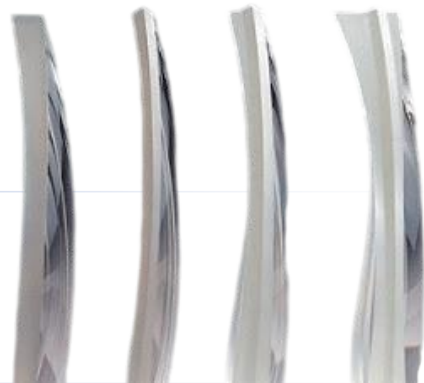

Easy to operate
Sharp edge precise positioning
Efficient grinding

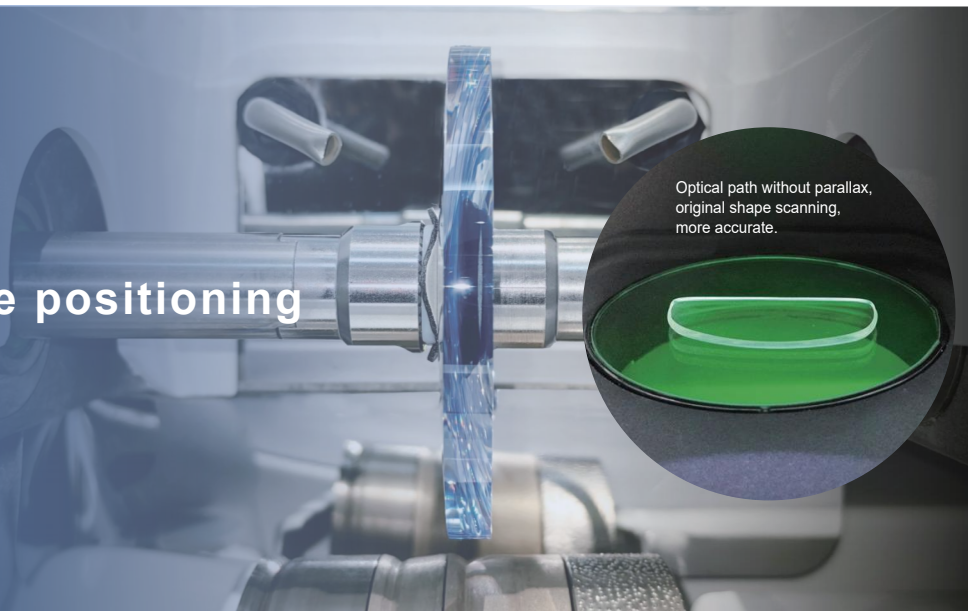

【3D Forced Sharp Edge】 Function: Sharp Edge Ratio Can Be Adjusted Freely



Measure the front base curvature of the lens

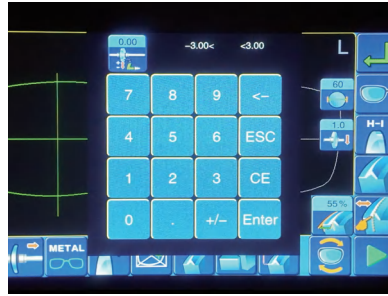

Input obtained data



Easy implementation of perfect edge shapes

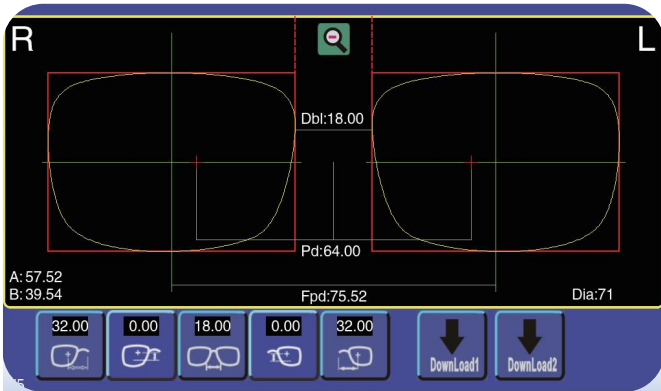

Scan settings interface, 1:1 graphic display



Digital template function, which can adjust and adjust the shape of the lens

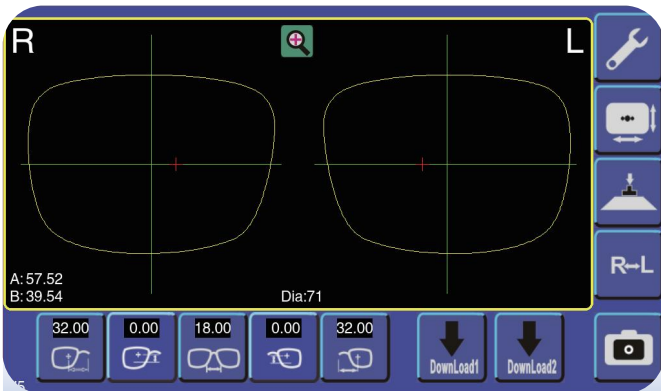

Setting and grinding interface, which can achieve standardized and procedural grinding operations

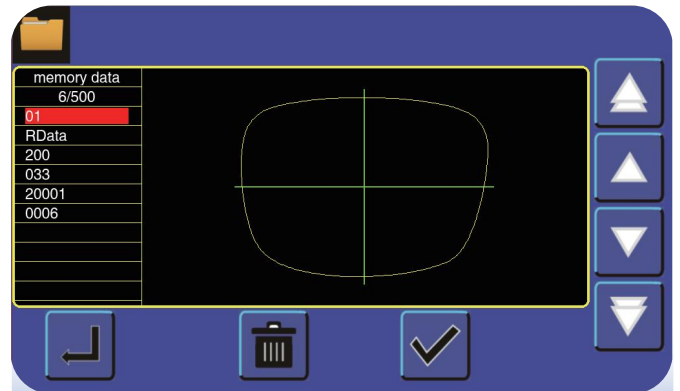

Quick indexing function



Flip and install suction cups for easier operation

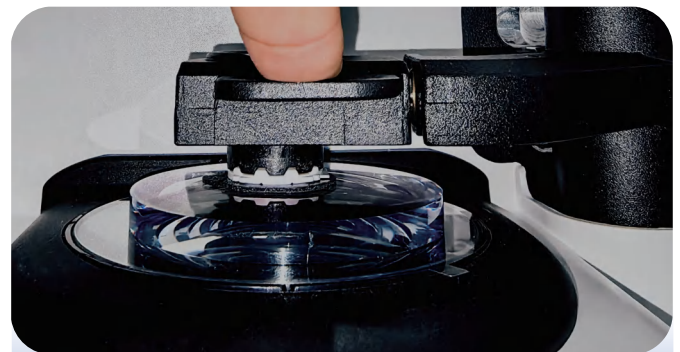

Scan center all-in-one machine

SHANGHAI LINK INSTRUMENTS



Technical Specifications

ALE-1500 (3D)

Host Size (L*W*H):	650*550*480mm
Packing Size (L*W*H):	798*706*673mm
Weight:	60Kg
Power Supply:	AC220V/110V 50/60Hz
Electric Power:	500W
Machining Accuracy:	Diameter Deviation 0.1mm
Machining Size Range:	22mm ~ 70mm
Axis Adjustment Accuracy:	0.5°
Step Distance of Size Adjustment:	0.05mm
Clamping Pressure:	80~110Kg
Lens Materials:	CR39, GL, POLY, H-I, HC
Edge Shape:	Bevel, Flat, Bevel Polishing, Flat Polishing



Technical Specifications

Scanner

Host Size:	217*232*413mm
Packing Size (L*W*H):	568*418*365mm
Weight:	10Kg
Power Supply:	AC100-240V 50/60Hz
Electric Power:	50W
Light Source Adjustable Range:	The radius can be lowered by 6mm
Screen Rotary Angle:	0 ~ 130°
Storage:	500 Pairs
Touch Screen:	7 Inch capacitive screen
Quantity of connectable hosts:	2 Sets



Add.No.1101 Huyi Highway,Shanghai,201802,China
Tel.+86-21-69512871
Fax.+86-21-69512872
E-mail.sales@linkcsh.com
Http://www.cnlink-group.com

SHANGHAI LINK INSTRUMENTS CO.,LTD.